

**Features**

1. Current transfer ratio  
(CTR : MIN.50% at  $I_F=5mA$   $V_{CE}=5V$ )
2. High isolation voltage between input and output(Viso : 5000Vrms).
3. Compact dual-in-line package.

**Applications**

1. Registers, copiers, automatic vending machines.
2. System appliances, measuring instruments.
3. Computer terminals, programmable controllers.
4. Communications, telephone, etc.
5. Electric home appliances, such as oil fan heaters, Microwave oven, Washer, Refrigerator, Air conditioner, etc.
6. Medical instruments, physical and chemical equipment.
7. Signal transmission between circuits of different potentials and impedances.
8. Facsimile equipment, Audio, Video.
9. Switching power supply, Laser beam printer.

**Outside Dimension:Unit (mm)**

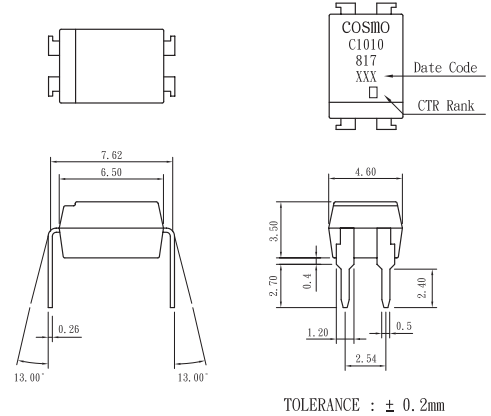

**Schematic:Top View**

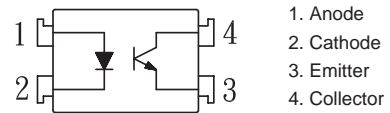

**Absolute Maximum Ratings**

( $T_a=25^\circ C$ )

Parameter		Symbol	Rating	Unit
Input	Forward current	$I_F$	50	mA
	Peak forward current	$I_{FM}$	1	A
	Reverse voltage	$V_R$	6	V
	Power dissipation	$P_D$	70	mW
Output	Collector-emitter voltage	$V_{CEO}$	70	V
	Emitter-collector voltage	$V_{ECO}$	6	V
	Collector current	$I_C$	50	mA
	Collector power dissipation	$P_C$	150	mW
Total power dissipation		$P_{tot}$	200	mW
Isolation voltage 1 minute		Viso	5000	Vrms
Operating temperature		$T_{opr}$	-30 to +115	$^\circ C$
Storage temperature		$T_{stg}$	-55 to +125	$^\circ C$
Soldering temperature 10 second		$T_{sol}$	260	$^\circ C$

**Electro-optical Characteristics**

( $T_a=25^\circ C$ )

Parameter		Symbol	Conditions	MIN.	TYP.	MAX.	Unit
Input	Forward voltage	$V_F$	$I_F=20mA$		1.2	1.4	V
	Peak forward voltage	$V_{FM}$	$I_{FM}=0.5A$	旻		3.0	V
	Reverse current	$I_R$	$V_R=4V$			10	$\mu A$
	Terminal capacitance	$C_t$	$V=0, f=1kHz$	旻	30		pF
Output	Collector dark current	$I_{CEO}$	$V_{CE}=20V$			0.1	$\mu A$
Transfer characteristics	Current transfer ratio	CTR	$I_F=5mA, V_{CE}=5V$	50		600	%
	Collector-emitter saturation voltage	$V_{CE(sat)}$	$I_F=20mA, I_C=1mA$		0.1	0.2	V
	Isolation resistance	Riso	DC500V	$5 \times 10^{10}$	$10^{11}$		ohm
	Floating capacitance	$C_f$	$V=0, f=1MHz$		0.6	1.0	pF
	Cut-off frequency	$f_c$	$V_{CC}=5V, I_C=2mA, R_L=100ohm$		80		kHz
	Response time (Rise)	$t_r$	$V_{CE}=2V, I_C=2mA, R_L=100ohm$		4	18	$\mu s$
Response time (Fall)	$t_f$			3	18	$\mu s$	

Classification table of current transfer ratio is shown below.

Model NO.	CTR (%)
A Rank	80 TO 160
B Rank	130 TO 260
C Rank	200 TO 400
D Rank	300 TO 600
E Rank	50 TO 600

**Fig.1** Current Transfer Ratio vs. Forward Current

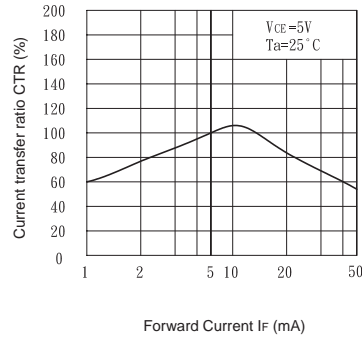

**Fig.2** Collector Power Dissipation vs. Ambient Temperature

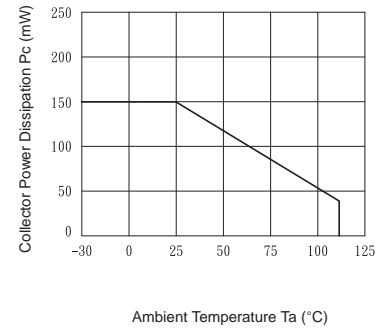

**Fig.3** Collector Dark Current vs. Ambient Temperature

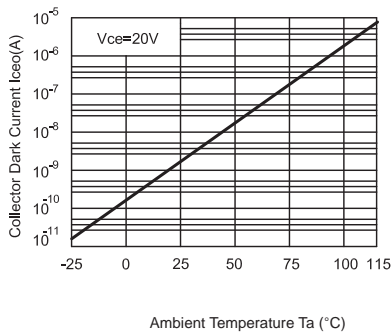

**Fig.4** Forward Current vs. Ambient Temperature

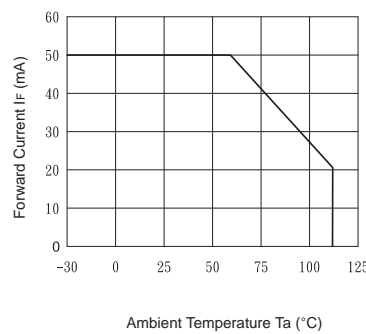

**Fig.5** Forward Current vs. Forward Voltage

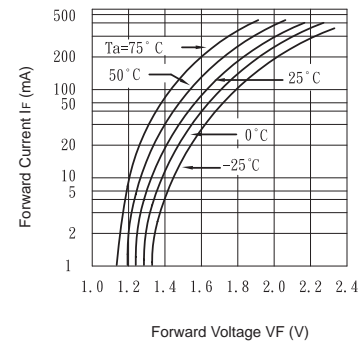

**Fig.6** Collector Current vs. Collector-emitter Voltage

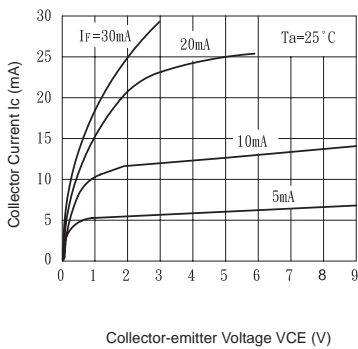

**Fig.7** Relative Current Transfer Ratio vs. Ambient Temperature

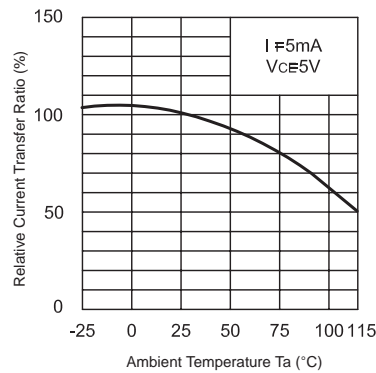

**Fig.8** Collector-emitter Saturation Voltage vs. Ambient Temperature

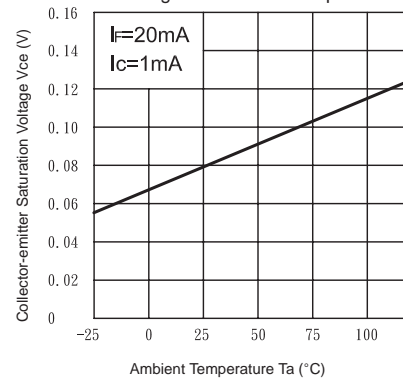

**Fig.9** Collector-emitter Saturation Voltage vs. Forward Current

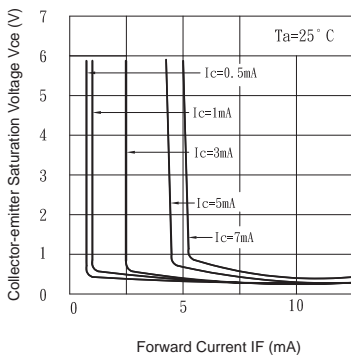

**Fig.10** Collector Current vs. Ambient Temperature

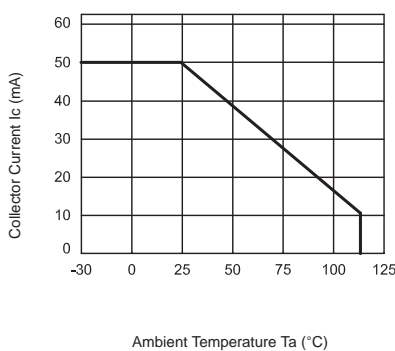

**Fig.11** Input Power Dissipation vs. Ambient Temperature

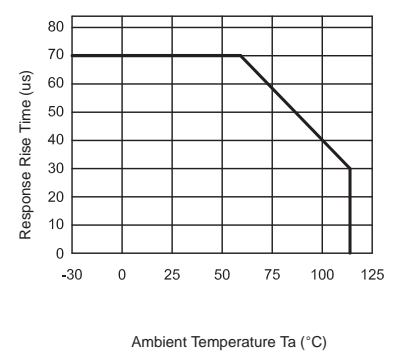

**Fig.12** Response Time vs. Load Resistance

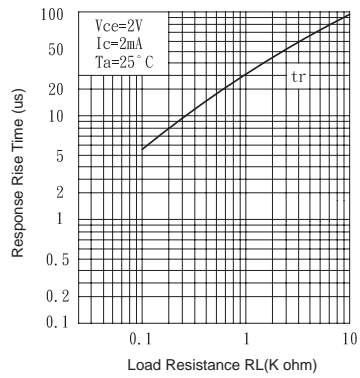

**Fig.13** Response Time vs. Load Resistance

